

Zawias 270°  
Hinge 270°  
Петля 270°



ZASTOSOWANIE / APPLICATION / ПРИМЕНЕНИЕ



PARAMETRY / CHARACTERISTICS / ХАРАКТЕРИСТИКИ

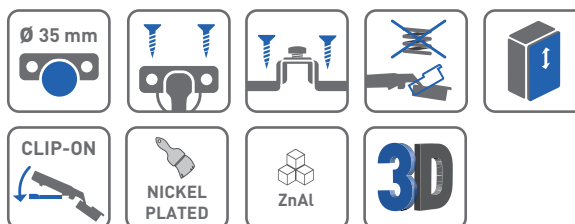

PAKOWANIE / PACKING / УПАКОВКА



SKŁAD ZESTAWU / SET INCLUDES / КОМПЛЕКТАЦИЯ

ZAWIAS NAKŁADANY  
OVERLAY DOOR  
НАКЛАДНАЯ ПЕТЛЯ

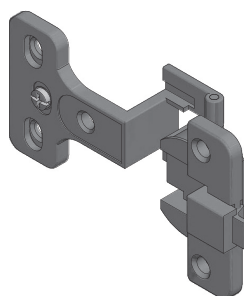

ZP-KT0270-BE	—	—

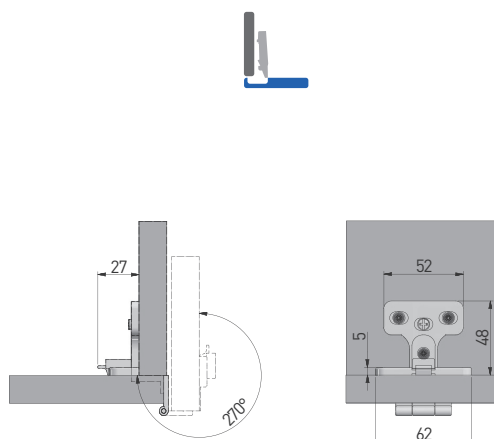

MONTAŻ / MOUNTING / МОНТАЖ

montaż prowadnika w korpusie  
mounting plate installation  
присадка под ответную планку

montaż puszki we froncie  
hinge cup installation  
присадка под чашку петли

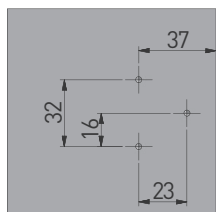
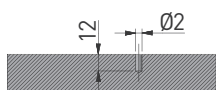

ZP-KT0270-BE

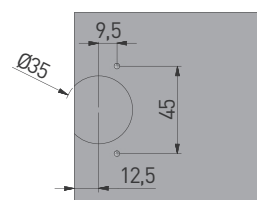
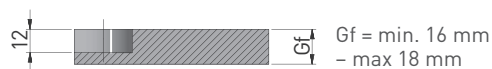

Gf = grubość frontu  
front thickness  
толщина фасада

REGULACJA / ADJUSTMENT / РЕГУЛИРОВКА



± 1,5 mm