

\* szerokość maksymalna dotyczy montażu z dystansami bocznymi dla szafek szerszych istnieje możliwość montażu bez dystansów (tylko do wieńca dolnego)

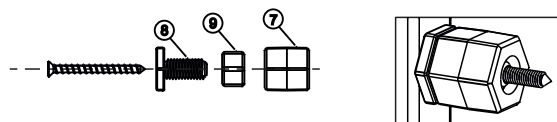

A

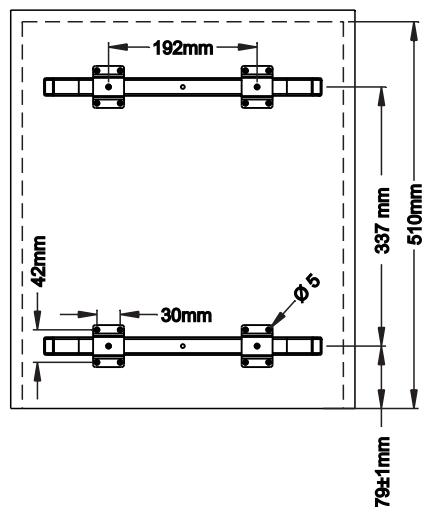
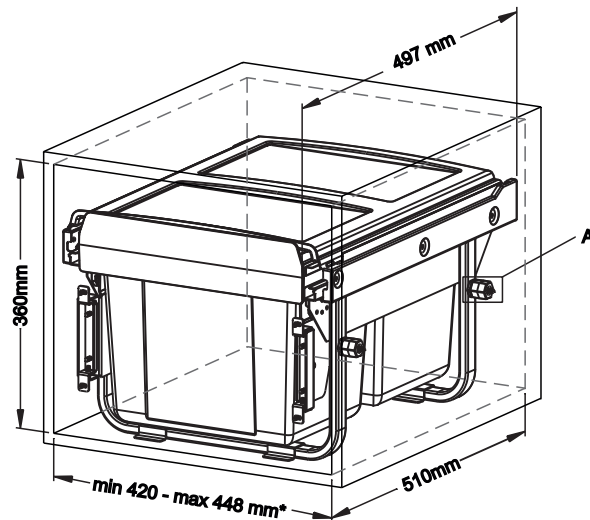
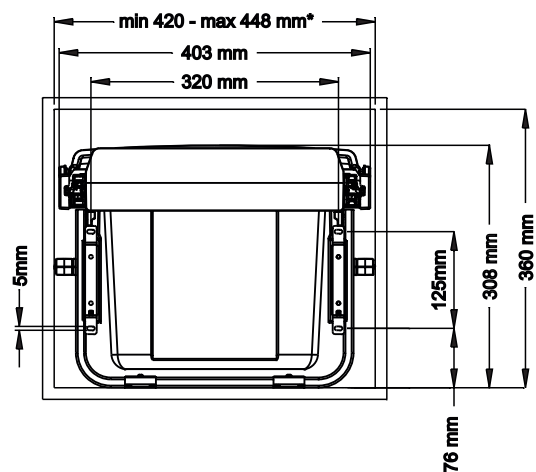
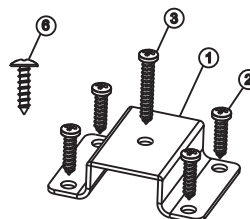
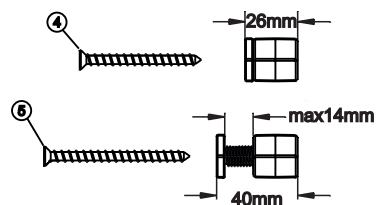

BOM List		
1	Sandle Brackets	4PCS
2	PA4X16 Screws	16PCS
3	PA4X25 Screws	6PCS
4	KA4X50 Screws	4PCS
5	KA4X60 Screws	4PCS
6	TA4X14 Screws to front	4PCS
7	Plastic Distance	4PCS
8	Plastic Screws	4PCS
9	Hexagon Screws M10	4PCS

Index / Index / 索引号	PB-45-MF2X15-60A	
Nazwa / Description / 货名	Segregator 450:kosze 2x15l	
Materiał / Material / 材料	tworzywo sztuczne	
Pokrycie Finish 颜色		antracyt
Ciężar netto Netto weight 净重	kg	6,6kg
Opakowanie Packing 包装	kpl.	1
Waga opak. brutto Gross weight packing 毛重包装	kg	7,4kg
Zawart. zestawu Content of set 每套包括	kosz 15L z uchwytem (2 szt.) / rama/ wkrety + mocowanie/dystanse boczne	
Skala / Scale / 比例	Str. / Page / 页	1 / 1
Data / Date / 日期	19/09/2014	

**GTV**®

GTV sp. z o.o. S.K.A.  
ul. Przejazdowa 21  
05-800 Pruszków, Polska